



VERTIGO 30

sottovuoto verticale
vertical vacuum packaging machines



YouTube











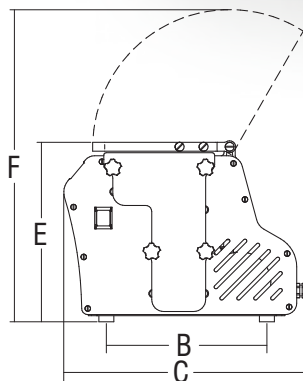
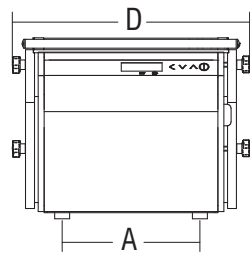
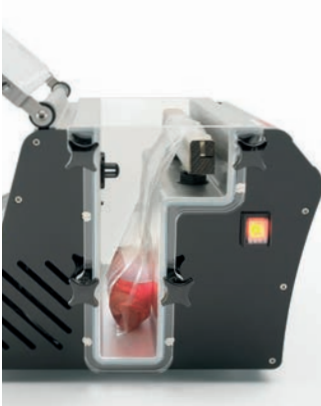





Industria 4.0

- Sottovuoto compatta verticale ideale per liquidi, granulati e polveri per utilizzo nei bar o come seconda macchina.
- Max misura sacchetto mm 300x350 che riesce a contenere 3 Lt
- Controllo EASY TOUCH (pag. 176)
- Coperchio senza pistoni
- Pratiche nicchie sul profilo uso maniglia
- Straordinaria soluzione brevettata per la pulizia interna:
- Fianchi laterali della vasca trasparenti offrono una visibilità perfetta all'interno vasca
- Fianchi laterali sono facilmente e completamente smontabili senza attrezzi per poter pulire agevolmente e a fondo dentro la vasca

- *Vertical compact vacuum packaging machine ideal for liquids, granulates and powders best for bars or as a second machine.*
- *Max bag size 300x350 mm which can easily hold 3 Lt*
- *EASY TOUCH controls (pag. 176)*
- *Lid without pistons*
- *Practical niches on the profile to move the unit*
- *Extraordinary patented solution for internal cleaning:*
- *Transparent sides of the tank offer perfect visibility inside the tank*
- *Side panels can be easily and completely disassembled without tools for easy and thorough cleaning inside the tank*





													
	kw	1ph	mc/h	mm	mm	mm	mm	mm	mm	mm	kg	mm	kg
Vertigo 30	0.15	1ph	4	310	326x60x250	230	268	416	396	300	22	515x435x385	24